



**USER MANUAL**

**SYN 2500 PULSE**



**CE**



Please read carefully this user manual before using this machine

Keep it for the future use.

## MANU

SAFETY	3
APPLICATION	6
DESCRIPTION OF THE MACHINE	6
TECHNICAL DATA OF THE DEVICE	6
DEVICE CONNECTION - WELDING POLARITY SETTING	7
PANEL OPERATION-GENERAL	12
-SYNERGY MODE FOR MAG/MIG	15
-MIG OPERATION	17
-TIG OPERATION	24
-MMA OPERATION	26
ERROR CODE	28
ELETRICITY SAFETY GUIDLINES	29
ELECTRICITY DIAGRAM	30

## 1. Safety

It is imperative that you read the following signs and safety rules to protect your own and other people's health and life.



Read the instructions before starting the device. Use only original equipment supplied by the manufacturer.



Some components may explode. Always use a face shield and protective clothing with long sleeves.



Static voltage can damage electronic components.



Use approved face shields and welding shields. Always use protective clothing designed for welders. Metal splinters can damage your eyes. Always use safety glass.



Electric shock can result in death. Do not touch electrical components when the device is connected to power. Use dry and complete protective gloves and protective clothing.



Gases and vapors can be hazardous to health. Welding gases and fumes are emitted during the welding process. Inhalation of these substances can be hazardous to health.

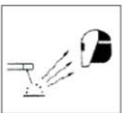

Eye protection with welding filters. Depending on the current used, use protective shields with appropriate filters.



Moving parts of the device can cause injuries.



Continuous operation for too long can cause device to overheat. Wait until the device cools down.

fire



Damaged technical gas cylinders may explode. The cylinders contain high pressure gas. Make sure that cylinders are handled and stored in accordance with health and safety and protection requirements.



Welded parts may burn.



The protruding wire from the torch is sharp and can cause skin puncture.



Danger of fire and explosion. During welding work, a fire may result. The welding station must be remote and protected against flammable and explosive materials.



The magnetic field can disrupt the functioning of pacemakers. Consult a doctor before starting work.



Do not weld at height without proper protection.



A device falling or falling over may cause injury.

- Before starting work, specify the place where the device is to be operated.
- The device should be connected to the network so that it can be freely manipulated at all times.
- The power cord should not be taut during operation.
  
- Do not use the device on a surface that may cause it to tip over.
  
- To move the device, use only the handle on the front of the device. Do not pull on the welding or power cord.
  
- Moving and transporting the device and cylinders with technical gases should be carried out separately. Only carry the machine using the factory carrying handles.
  
- Incorrect use is prohibited.

### ATTENTION!

The heating test was carried out at ambient temperature and the duty cycle (load factor) at 25°C was determined as a result of the simulation.

The device is intended for conducting professional welding works in industrial conditions by personnel having valid qualification certificates in accordance with applicable standards.



WARNING: This Class A equipment is not intended for use in residential areas where electricity is supplied through the public low voltage network system. There may be potential difficulties in ensuring electromagnetic compatibility at these locations due to conducted and radiated disturbances.

The device should be operated in accordance with the Regulation of the Minister of Economy of April 27, 2000. on health and safety at work during welding (Journal of Laws No. 40 item 470)

Keeping this user manual and following the guidelines outlined in it will allow for proper maintenance of the device in the future. The following warnings are intended to ensure user safety and environmentally friendly operation. Read the entire manual carefully before installing and using the device.

- After opening the packaging, check that the device has not been damaged during transport. If in doubt, contact our service department.
- The device should only be used by a trained employee or consumer.
- When installing the appliance, you should entrust all electrical activities to a qualified electrician.

## 2. APPLICATION

SYN 2500 PULSE devices are used for manual arc welding in the GMAW (Gas Metal Arc Welding), GTAW (Gas Tungsten Arc Welding) and SMAW (Shielded Metal Arc Welding) methods.

## 3. DESCRIPTION OF THE MACHINE

SYN 2500 PULSE devices are modern inverter sources offering very high welding versatility. Their main advantage is the possibility of welding using single or double pulse current in MIG or MAG mode. Thanks to the use of modern IGBT technology and high-quality components, they are ideal for works related to the automotive industry, steel constructions, welding of aluminum alloys and others.

Reliability, a wide range of applications (the ability to carry out work in three welding methods: MIG / MAG, TIG-LIFT DC, MMA make the device satisfy even the most demanding users.

## 4. TECHNICAL DATA OF THE DEVICE

Characters		SYN 2500 PULSE
Rated input voltage[V]		220V
Frequency[Hz]		50/60
Security[A]		20
Output current range[A]	MMA	30-250
	TIG	10-250
	MIG/MAG	40-250
Output voltage	MMA	21.2-32
	TIG	10.4-22
	MIG/MAG	16-32
Duty cycle[%] (at ambient temperature 40°C)		30% 250 [A]
Rated input power [kVA]		13.9
Power factor		0.93
Work piece thickness[mm]		0.5-6
Feeder type		2R
Welding wire diameter[mm]		0.8/1.0/1.2
Insulation class		F
Protection class		IP21
Net weight [kg]		29
Dimensions [mm]		270X600X540

**5. DEVICE CONNECTION - WELDING POLARITY SETTING**

**MIG/MAG WELDING**

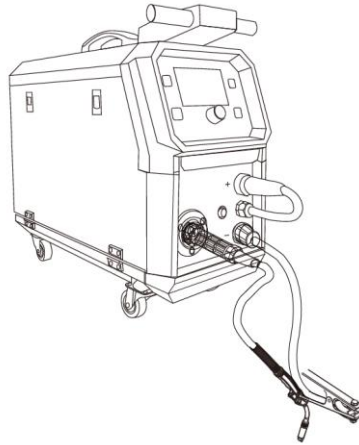

Select the correct welding polarity as shown above.

Positive polarity welding (MIG / MAG gas shielded solid wire welding)

Welder's current plug connected to the positive + socket (EURO)

Earth handle connected to the negative socket -

**Welding with negative polarity - (welding with flux cored wire - FCAW)**

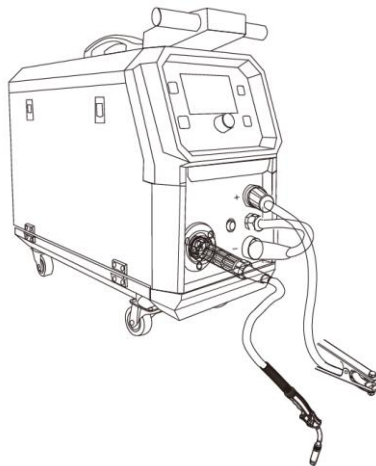

Welder's current plug connected to the negative socket - (EURO)

Earth clamp connected to the positive socket +

**WARNING!**

To start working with self-shielding wire, change the polarity inside the device - on the wire feeder.

**BEFORE YOU WORK:**

- Check the voltage, number of phases and frequency of the power supply before connecting the device to the mains.
- Power supply voltage parameters are given in the chapter with technical data and on the rating plate of the device.
- Check the connection of the grounding wires of the device to the mains.
- Ensure that the power supply network can provide coverage of the input power demand for this device under normal operating conditions. The fuse size, the parameters of the power cord are given in the technical data and on the rating plate. Connection and replacement of the power cord and plug should be made by a qualified electrician.
- Remove all flammable materials from the welding area.
- Use appropriate protective clothing for welding: gloves, apron, work boots, mask or visor with appropriate certificates.

### DEVICE CONNECTION FOR THE MIG / MAG METHOD

- To extend the service life and ensure reliable operation of the device, observe the following rules:
- The device should be placed in a well-ventilated room with free air circulation.
- Do not place the device on wet ground.
- Use an electrode wire with diameter and spool weight in accordance with the manufacturer's instructions (D200, max. 15 kg). Check the technical condition of the device and welding cables on an ongoing basis.

#### Welding wire spool assembly:

SYN 2500 PULSE device is equipped with professional wire feeder, it has 4 rolls feeder enabling work with 2 handles max 4mb when welding with steel wire and with 3mb when welding with aluminum alloy wire, The welding wire holder allows the installation of reels with a diameter of 300mm-15kg.

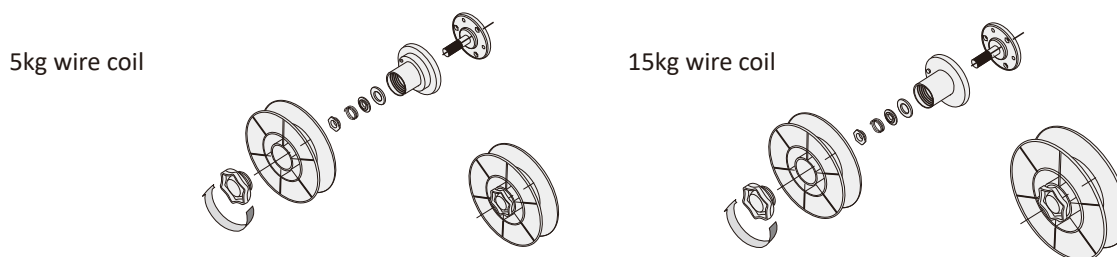

- Lift the side cover of the semi-automatic housing.
- Ensure that the rollers fitted in the drive unit match the type and diameter of wire used. Rolls should be used for steel wires with "V" shaped grooves, while for aluminum wires with "U" type grooves.



- Apply welding wire spools to the spool clamping mechanism, paying attention that the unwinding direction of the wire is consistent with the direction of the wire's entry into the drive unit. Lock the spools before slipping by tightening the nut on the spool mounting body.
  - The end of the wire should be straightened or cut off a bent section.
  - To feed wire into the feeder, release the pressure of the feed rollers.
  - Insert the end of the wire into the guide located at the back of the feeder and route it over the drive roller by inserting it into the welding gun stub.
  - Tighten the wire in the drive roller groove and tighten.
  - Remove the gas nozzle from the burner and unscrew the contact tip.
  - Turn the device on.
  - Unwind the welding gun cable so that it is straight. ATTENTION! Do not drive the welding torch ends towards the face or other people.
  - Press the welding button on the welding gun and hold it until the wire appears behind the torch.
  - When the end of the welding wire passes through the connector in the torch, release the button approx. 5 cm and replace the contact tip and gas nozzle.
- 
- Adjust the clamping force by turning the knob, clockwise-increases the clamping force, to the left-decreases the clamping force. Too low clamping force will cause the drive roller to slip. Too much pressure increases the feed resistance and deforms the wire.

**We recommend placing the wire into the welding gun with the valve on the shielding gas cylinder closed. This will reduce its unnecessary losses.**

### Installation of shielding gas cylinders:

- A cylinder with a suitable shielding gas must always be properly secured against falling over. If possible, attach to an approved welding carriage with the MIG / MAG device. The trolley is not standard equipment of the set.
- 
- Connect the semi-automatic machine to the cylinder with a suitable hose. Unscrew the regulator valve before starting to weld. **Always close the cylinder valve after welding.**

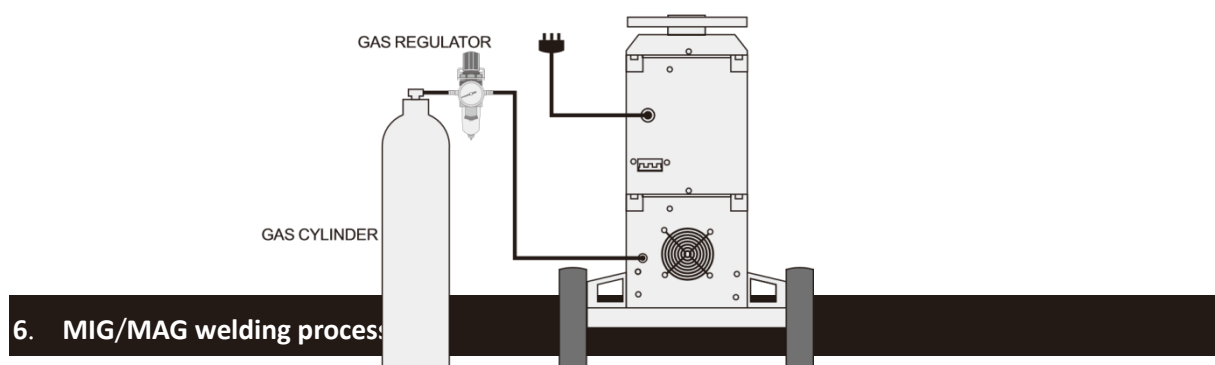

Arc welding in gas shields (marked MIG / MAG) is one of the most commonly used processes in the production of welded structures. The abbreviation MAG (Metal Active Gas) includes in its description types of active protective gases. The abbreviation MIG (Metal Inert Gas) refers to inert gas shields.

The semi-automatic welding process involves fusing the edges of the work piece and the consumable electrode material with the heat of an electric arc glowing between the electrode in the form of a solid wire and the welded part, in an inert or active gas shield.

The main protective gases used for MIG welding are inert gases such as argon, helium and MAG active gases: CO<sub>2</sub>, H<sub>2</sub>, O<sub>2</sub>, N<sub>2</sub> and NO, used separately or as additives to argon or helium.

The fusible electrode is in the form of a solid wire, usually 0.6-1.2 mm in diameter, and is fed in mm, and is fed in m / min upwards. Welding torches can be cooled by liquid or shielding gas. Welding is carried out mainly with direct current with positive polarity, as semi-automatic, mechanized welding, direct current with positive polarity, as semi-automatic, mechanized, automatic or robotic welding using specialized equipment. The shield of the welding arc glowing between the consumable electrode and the material being welded ensures the formation of the weld under very favorable thermal and chemical conditions. This type of welding can be used to make high-quality joints of all metals that can be joined by arc welding. These include: carbon and low alloy steels as well as corrosion resistant steels. Welding can be carried out in workshop and field conditions in all positions.

### SINGLE PULSE MODE

MIG PULSE is an advanced form of welding that uses the best of the forms of the transfer of molten electrode material to the work piece. Unlike short circuits, pulse welding does not produce spatter and there is a risk of cold "leakage". Welding positions in the pulse are not limited because they are derived from globular or spray forms, and their use is definitely more efficient. By cooling the spray arc process, pulsed MIG is able to extend the welding range, and smaller heat input does not cause a problem with burning thin materials. MIG PULSE is one of the best welding processes for a wide range of applications and types of metal.

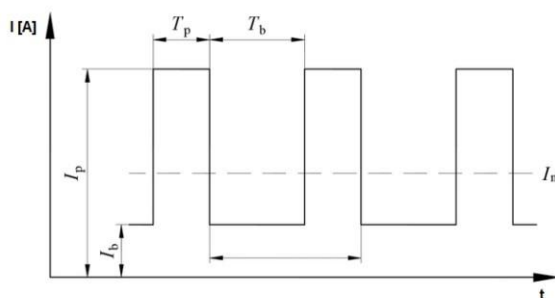

### DOUBLE PULSE MODE

Welding with the MIG / MAG method with double pulse we get a high level of face appearance (husk effect). In addition, the use of automatic wire feed affects welding performance. The MIG / MAG method with double pulse allows the regulation of current pulsation (pulse balance) and adjustment of the wire feed speed. Thanks to this, we improve the appearance of the weld. When MIG / MAG welding with double pulse, current pulses occur in two ranges. The sequential system of our devices automatically combines two levels of pulses.

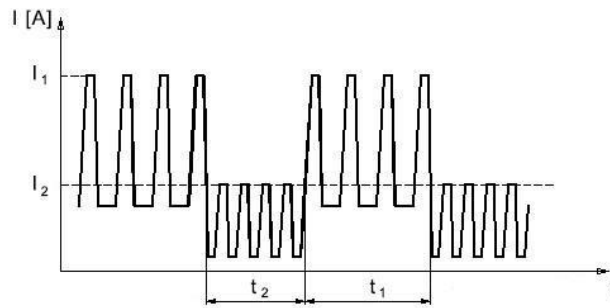

**The benefits of using the MIG MAG method with double pulse are:**

1. MIG / MAG double pulse welding is faster than TIG welding.
2. MIG / MAG double pulse welding achieves high aesthetics like the TIG method.
3. MIG / MAG double pulse welding results in less deformation than TIG.

## 7. PANEL OPERATION

### A. DESCRIPTION OF THE CONTROL PANEL

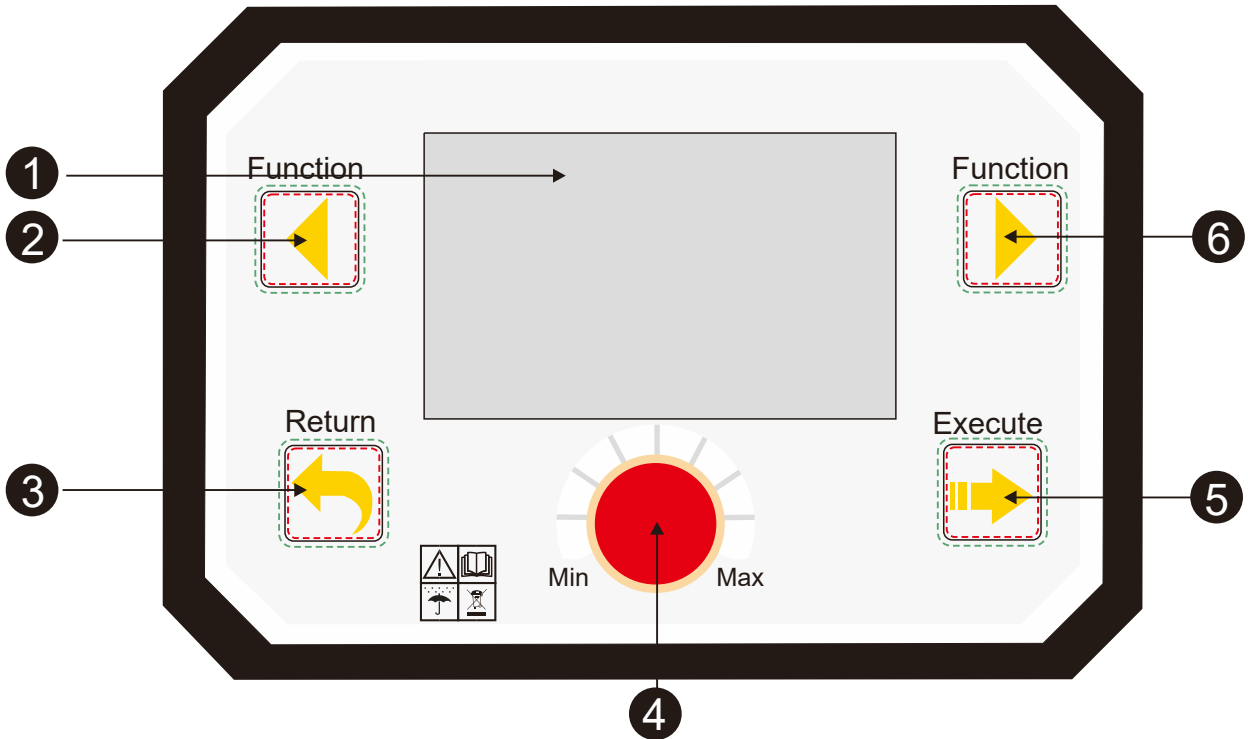

1. LCD display
2. Function selection button, to select the previous menu, holding for 5 seconds to save the current setting in memory.
3. Button to return to the previous menu. (additionally held for 5 seconds to return to the factory settings (RESET)).
4. Adjustment knob,  
Turn - Select and Adjust.  
Press - Confirm and Switch to next.
5. Button for Confirmation or Enter.
6. Function selection button, to select the next menu, holding for 5 seconds to recall memories;  
The device has 18 memory programs.

## B. LANGUAGE SELECTION



The device allows you to set the following control languages: English, German, Dutch, French, Spanish.

Turn the red knob of the front panel to select the language then press for confirmation.

## C. CHOICE OF WELDING METHOD



This page allows you to select welding methods as below:  
Synergy, MIG, LIFT-TIG, MMA

Turn the red knob of the front panel to select the welding mode then press for confirmation.

**SYNERGY** - synergic settings. The user selects the basic welding parameters such as the type of material, thickness of the material to be welded, diameter of the welding wire. Other parameters of the device are selected automatically using the database of uploaded programs.

**MIG MODE** - welding using individual user settings. The system suggests the selection of key welding parameters, indicating the thickness of the welded material when adjusting them. This information suggests to the user that the settings are correct.

**LIFT-TIG** - TIG lift mode (ignition of the arc by rubbing) - welding with a tungsten electrode in an inert gas shield. In order to carry out welding by this method, it is necessary to retrofit the device TIG torch with shielding gas control in the handle as in the photo below. **This handle is not a standard equipment of the set.**



**MMA MODE** - welding with coated electrode. In addition to welding current adjustment, the user can additionally set ARC-FORCE, HOT START and enable or disable the VRD protection system.

**ARC FORCE** - Stabilizes the arc regardless of fluctuations in its length, reduces the amount of spatter.

**HOT-START** - a function that makes welding easier. When the arc strikes, the welding current is temporarily increased to heat up the material and electrode at the point of contact, and to properly shape the penetration and weld face at the initial stage of welding.

**VRD** - the device has a VRD (Voltage Reduction Device) system, which for welding mode MMA with electrodes reduces the open circuit voltage, which significantly increases the user's safety. In special cases of using electrodes with high arc ignition current, problems with its initiation may occur.

D. Synergy function (MIG/MAG )



In the SYNERGY mode, the user only selects the basic welding parameters such as the type of material, the thickness of the material to be welded, and the diameter of the welding wire (0.8mm, 1.0mm and 1.2mm available). Other parameters of the device are selected automatically using the database of uploaded programs.

**The SYNERGY mode only allows continuous welding, it has no possibility to adjust the PULS and dual PULS settings.**

You can manually correct the synergic settings.

**NOTE:** If the material type and thickness settings are changed, the system will return with the remaining parameters to the factory default values.

	<p><b>Step 1-Choice of material</b></p> <p>The user selects the welded material (and welding wire) from the list of alloys available in the program.</p>
	<p><b>Step 2-Selecting the thickness of the work piece</b></p> <p>The user chooses the thickness of the welded material. The device automatically selects the intensity on this basis welding current, arc voltage and feeder speed.</p>
	<p><b>Step 3 Selecting the welding wire diameter</b></p> <p>You choose the welding wire diameter you plan to use.</p> <p><b>ATTENTION!</b> The device automatically reduces or increases its maximum power depending on the wire diameter.</p>

 <p>The screenshot shows the 'SYNERGY SETTING' screen. On the left, 'Current' is set to 120 A and 'Voltage' is 20 V. The central 'Setting' dial is at 12.5 m/min. On the right, the 'Parameter list' shows 'Thickness' with options for <math>\phi</math> 0.8 wire, <math>\phi</math> 1.0 wire (highlighted), and <math>\phi</math> 1.2 wire. At the bottom, 'Operation mode' is 2T, 'Pulse mode' is ON, 'Feeding speed' is 12.5 m/min, and 'Wire diameter' is <math>\phi</math> 1.0 mm.</p>	<p><b>Step 4 Selecting the welding wire diameter</b></p> <p>You choose the welding wire diameter you plan to use.</p> <p><b>ATTENTION!</b> The device automatically reduces or increases its maximum power depending on the wire diameter.</p>
 <p>The screenshot shows the 'SYNERGY SETTING' screen. On the left, 'Current' is set to 170 A and 'Voltage' is 20 V. The central 'Setting' dial is at 17.0 m/min. On the right, the 'Parameter list' shows 'Thickness' with options for <math>\phi</math> 0.8 wire, <math>\phi</math> 1.0 wire, and <math>\phi</math> 1.2 wire (highlighted). At the bottom, 'Operation mode' is 2T, 'Pulse mode' is ON, 'Feeding speed' is 17 m/min, and 'Wire diameter' is <math>\phi</math> 1.2 mm.</p>	<p><b>Step 5 Selecting the welding wire diameter</b></p> <p>You choose the welding wire diameter you plan to use.</p> <p><b>ATTENTION!</b> The device automatically reduces or increases its maximum power depending on the wire diameter.</p>

According to the programmed welding parameters, the welding wire diameters selected by the user directly influence the welding current and voltage, and wire feeder speed. For example, choosing a 0.8mm wire will automatically limit the maximum welding current to e.g. 140A, choosing a 1.0mm wire will allow welding 200A current. These actions are aimed at optimizing the welding process and avoiding problems associated with burning the wire too quickly just after the contact tip in a situation where it is no longer possible to increase the feeder speed.

The inability to set the maximum welding current is not a software error and results from the welding wire diameter selected.



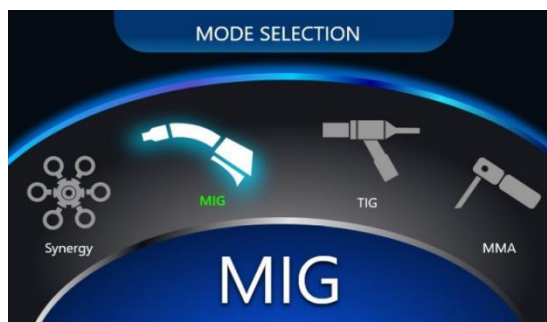

**E. MIG/MAG OPERATION**





In MIG welding mode, the user sets all welding parameters one after the other. The system suggests the selection of optimal welding parameters by indicating at their adjustment thickness of the welded material (see table - setting the wire feeder speed). This information suggests to the user that the settings are correct. Depending on the welding style (forced positions, fast welding with higher current or slower current with lower intensity), these settings may require a slight adjustment by the user.

	<p><b>Handle mode button operation</b></p> <p>2-step, 4-step welding and spot welding selection.</p>
	<p><b>Welding current selection:</b></p> <ul style="list-style-type: none"> <li>- continuous (without pulse)</li> <li>- single pulse (see chapter WELDING MIG / MAG WITH PULSE)</li> <li>- double pulse (see chapter WELDING MIG / MAG WITH DOUBLE PULSE)</li> </ul>
	<p><b>Choice of welding wire diameter</b></p> <p>Choose the corresponding wire diameter.</p>

	<p><b>Choice of welded material (and wire)</b> From the list of alloys available in program.</p>
	<p><b>Setting the wire feeder speed ATTENTION!</b> It will show automatically the estimated thickness of the welded material in order to select the optimal welding parameter.</p>
	<p><b>Adjusting the arc voltage</b> Increasing or decreasing this value will lengthen or shorten the arc length.</p>
	<p><b>Inductance regulation</b> Properly selected welding inductance reduces the amount of spatter. It depends on the wire diameter welding, shielding gas used, current and welding position. Reducing the inductance makes the arc more stable and concentrated, while increasing contributes to the formation of a more fluid pool and reduces the amount of spatter. Properly selected, it is characterized by a stable arc, even transfer of liquid metal droplets, maintaining a constant weld pool size and characteristic repetitive sound without splashes and explosions.</p>



	<p><b>Adjusting the arc voltage</b></p> <p>Increasing or decreasing this value will lengthen or shorten the arc length.</p>
	<p><b>Inductance regulation</b></p> <p>Properly selected welding inductance reduces the amount of spatter. It depends on the wire diameter welding, shielding gas used, current and welding position. Reducing the inductance makes the arc more stable and concentrated, while increasing contributes to the formation of a more fluid pool and reduces the amount of spatter. Properly selected, it is characterized by a stable arc, even transfer of liquid metal droplets, maintaining a constant weld pool size and characteristic repetitive sound without splashes and explosions.</p>



**F. MIG / MAG WELDING WITH PULSE**

In order to start welding in MIG / MAG PULS mode, the settings should be made as in the previous chapter. Additional welding parameters in pulse welding mode are presented in the following tables:

	<p><b>Welding current selection2</b></p> <p>The pulse current function is mainly used when welding thin elements, low melting metals, e.g. lead, or welding in forced positions. Other advantages of pulsating current welding are the smaller heat affected zone, greater welding arc stability,</p>
	<p><b>Pulse frequency adjustment</b></p> <p>Changing this parameter extends or shortens the welding arc.</p> <p><b>ATTENTION!</b></p> <p>The pulse frequency is automatically selected based on the other welding parameters, there is no need to manually correct it.</p>
	<p><b>Pulse cycle setting</b></p> <p>Adjusting this parameter causes increasing or reducing the amount of spatter during welding.</p> <p><b>ATTENTION!</b></p> <p>The pulse cycle value is automatically selected based on the other welding parameters, there is no need to manually correct it.</p>

**G. MIG / MAG WELDING WITH DOUBLE PULSE**

To start welding in MIG / MAG mode, double PULSES should be pre-set as in the BASIC MIG / MAG SETTINGS chapter. Additional welding parameters in mode double pulse current welding is shown in the table below:

	<p><b>Welding current selection 3 - double pulse</b> Choose double pulse when welding aluminum.</p>
	<p><b>Selection of wire feeder speed ATTENTION!</b> When adjusting this parameter, you can refer to the dynamic thickness data that shown on the left, until the data match with the real thickness of the work piece. or change a little bit as you need.</p>
	<p><b>Double pulse frequency setting</b> In order to achieve optimal welding parameters, it is suggested to set the range from 1 to 2 Hz.</p>
	<p><b>Double pulse cycle setting</b> In order to achieve optimal welding parameters, it is suggested to set the range from 30 to 40%.</p>





**Setting the minimum wire feeder speed**  
**ATTENTION!**

When adjusting this parameter, you can refer to the dynamic thickness data that shown on the left, until the data match with the real thickness of the workpiece. or change a little bit as you need.

To achieve optimal welding parameters, setting the value is suggested corresponding to 70 to 90% of the maximum feeder speed.

H. SAVE AND RECALL FUNCTION

The device is equipped with a memory bank that allows you to save 18 user programs. The method of saving and reading data stored in the device cache is described below:



Holding the button  for 5 seconds will call the save page out, then select the job number and confirm.



Holding the button  for 5 seconds will call the save page out, then select the job number and confirm.

**I. MIG Setting Chart**

MIG Welding Current-Wire Diameter And Plate Thickness Chart							
Wire diameter	Plate thickness	1mm	2mm	3mm	4mm	5mm	6mm
AL-Si1.0/(4043) (DCEP)	Wire speed (M/min)	2.0	4.2	5.8	7.0	8.5	10.0
	Welding current (A)	24	58	85	107	133	160
	Arc voltage	16.0	18.3	19.2	21.0	22.5	23.6
AL-Si1.2/(4043) (DCEP)	Wire speed (M/min)	1.5	3.0	4.5	6.5	7.8	9.0
	Welding current (A)	27.0	64	100	143	173	200
	Arc voltage	16.5	17.8	19.5	22.5	24.5	25.3
Al-Mg1.0/(5356) (DCEP)	Wire speed (M/min)	2.5	6.0	8.0	11.0	12.5	14.0
	Welding current (A)	30	70	95	130	148	167
	Arc voltage	14.8	18.3	19.8	22.8	23.4	23.9
Al-Mg1.2/(5356) (DCEP)	Wire speed (M/min)	2.2	4.0	5.3	7.5	8.5	9.5
	Welding current (A)	33	65	89	128	141	152
	Arc voltage	15.7	17.2	17.7	19.3	20.0	21.2
AL1.0/(1070) (DCEP)	Wire speed (M/min)	2.8	5.3	7.0	8.5	10.0	11.3
	Welding current (A)	37	77	107	133	160	179
	Arc voltage	16.9	18.9	21.0	22.5	23.6	24.1
Al-Si 1.2/(1070) (DCEP)	Wire speed (M/min)	1.7	3.2	4.0	5.8	6.9	8.0
	Welding current (A)	30.0	68.0	88.0	127.0	152.0	178.0
	Arc voltage	16.7	18.0	18.8	21.6	22.9	24.9
Cu-Si1.0/(CuSi) (DCEP)	Wire speed (M/min)	4.0	9.0	12.0	14.0	16.0	18.0
	Welding current (A)	70.0	156.0	200.0	237.0	260.0	290.0
	Arc voltage	19.0	23.8	25.5	27.0	29.0	31.0
Cu-Si1.2/(CuSi) (DCEP)	Wire speed (M/min)	2.8	5.4	6.8	8.5	9.4	10.2
	Welding current (A)	72.0	153.0	194.0	220.0	241.0	264.0
	Arc voltage	19.7	23.5	25.6	28.5	29.6	30.8
Instruction: 4xxx means Al-Si wire, 5xxx means Al-Mg wire, 1xxx AL wire, Al and Al-Si wire both use Al-Si Function.							



TIG Welding



In the TIG (Tungsten Inert Gas) method, the electric arc strikes under an inert gas (argon) shield, between the welded element and the non-fusible electrode made of pure tungsten or tungsten with additives.

The TIG method is especially recommended for aesthetic and high-quality joining of metals, without laborious mechanical treatment after welding. However, this requires proper preparation and cleaning of the edges of both welded elements. The mechanical properties of the additive material should be similar to the properties of the welded parts. The role of shielding gas is always played by pure argon, supplied in quantities depending on the welding current set.

TIG(DCEN)

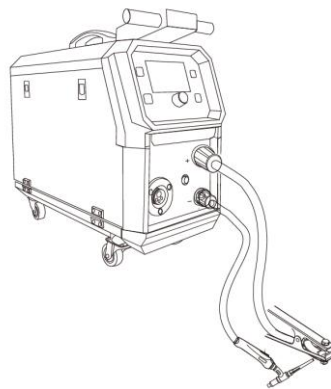

**Selection of welding current**

TIG welding is an additional option. The user can only adjust the welding current.

### **WELDING POLARITY IN THE TIG METHOD**

Negative polarity is used for most TIG welding operations. The welding gun is connected to the negative pole, while the earth gun is connected to the positive pole. In this way, the electrode consumption is reduced, the amount of heat accumulated in the welded material increases.

### **INFLUENCE OF ARC IN THE TIG LIFT METHOD**

To ignite the welding arc in the TIG LIFT method, unscrew the valve on the handle, press the button, then gently rub the tungsten electrode against the work piece and raise the torch lightly so that the arc ignites. Releasing the switch button ends the welding process (2T).



An example of a welding gun for the TIG lift method with a valve in the torch.

### **ATTENTION!**

The TIG torch is not standard equipment of the set.

**MMA WELDING**





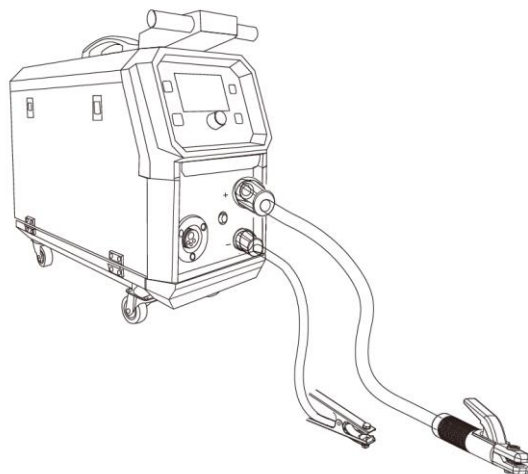

Arc welding is also called the MMA (Manual Arc Welding) method and is the oldest and most versatile arc welding method.

The MMA method uses a coated electrode, consisting of a metal core covered with a lagging. An electric arc is created between the end of the electrode and the material being welded. Arc ignition is created by touching the electrode with the end of the work piece. The welder feeds the electrode as it melts into the work piece so as to maintain a constant arc length and at the same time moves its melting end along the welding line. The melting coating of the electrode gives off protective gases that protect the liquid metal from the influence of the surrounding atmosphere, and then solidifies and forms a slag on the surface of the lake, which protects the coagulating weld from cooling too quickly and harmful environmental influences.





Connect the welding and mass leads to the appropriate output connectors of the welder, according to the polarity recommended by the manufacturer of the electrodes you intend to weld.

 <p>MMA SETTING</p> <p>Welding current 200 A Hot start current Force current VRD function</p>	<p><b>Welding current setting</b></p> <p>Adjust the welding current by spin the knob.</p>
 <p>MMA SETTING</p> <p>Welding current Hot start current Force current VRD function</p>	<p><b>HOT-START</b></p> <p>A function that makes welding easier. When the arc strikes, the welding current is temporarily increased to heat up the material and electrode at the point of contact, and to properly shape the penetration and weld face at the initial stage of welding.</p>
 <p>MMA SETTING</p> <p>Welding current Hot start current Force current 120 VRD function</p>	<p><b>ARC FORCE</b></p> <p>Stabilizes the arc regardless of fluctuations in its length, reduces the amount of spatter.</p>
 <p>MMA SETTING</p> <p>Welding current Hot start current Force current VRD function ON</p>	<p><b>VRD</b></p> <p>The device has a VRD (Voltage Reduction Device) system, which significantly increases user safety. In special cases of using electrodes with high arc ignition current, problems with its initiation may occur.</p>

**8. ERROR CODE**

In special cases, the following messages may appear on the display indicating a problem with the operation of the device. Errors on the display will appear until the defect is removed.

	<p><b>Error 001 Over current</b></p> <p>The device is operated beyond its rated efficiency. This message may also appear if you use an extension cord with the wrong diameter. After this message appears, turn the devices off for 5 minutes. If this message still appears after switching it on again, contact</p>
	<p><b>Error 002 Over heat</b></p> <p>The device is equipped with overheating protection. If the installed sensors find the temperature too high (e.g. fan failure or blocking), the device will switch off automatically and this message will appear</p>
	<p><b>Error 003 Wire feeder plugging</b></p> <p>The message appears when the wire in the feeder is blocked. This can happen when using 0.8mm wire when welding aluminum alloys.</p>

## 9. ELECTRICITY SAFETY GUIDELINES

### WORKING CONDITIONS

Optimal ambient temperature between -10 ° C and 40 ° C.

Avoid welding in sunny conditions and when it is raining, do not allow water to get inside the device. Avoid working in flammable, aggressive or dust environments.

### WORK SAFETY

Properly installed device with over voltage, over current protection and protection against excessive temperature will automatically turn off under conditions beyond those specified as standard.

However, prolonged use (e.g. over voltage) may damage the welding machine.

Therefore, the following guidelines should be followed:

### PRECAUTIONS

#### 1) Ensure good ventilation

The welder is a small device, through which a large current flows, and natural ventilation does not provide the necessary cooling. Therefore, to maintain stability, the welder is equipped with an internal cooling system. The operator should check that the ventilation opening is not blocked. The distance between the welder and the work piece should not be less than 0.3m. The operator should always pay attention to the ventilation of the device, because it depends not only on the obtained quality and welding results, but also on the service life of the device.

#### 2) Preventing overloading

Operators should observe (the load determined as the maximum permissible load for a given current) whether the welding current does not exceed the highest electric current permissible for the load. Electrical overload can significantly reduce the service life of the welder and even lead to the burning of its components.

#### 3) Over voltage prevention

The values given in the supply voltage line in the "Technical data" table should be kept. Under normal operating conditions, the automatic voltage compensation circuit ensures that the voltage remains within the permissible range. Supply voltage higher than the permissible value may damage the welder.

Operators should be fully aware of this threat and be able to take the appropriate steps.

#### 4) If the standard load is exceeded, the welder can enter protection mode and suddenly stop working.

This means that the standard load has been exceeded, thermal energy has tripped the thermal switch, which caused the device to stop. The indicator light on the welder's control panel lights up. In this situation, do not unplug the power plug to allow the fan to cool the welding machine. Turning the lamp off means that the temperature drops to a normal level. You can continue working.

